

Data Sheet



Article number: 0125113

Description: Retaining ring SP130
Spring steel

Measures

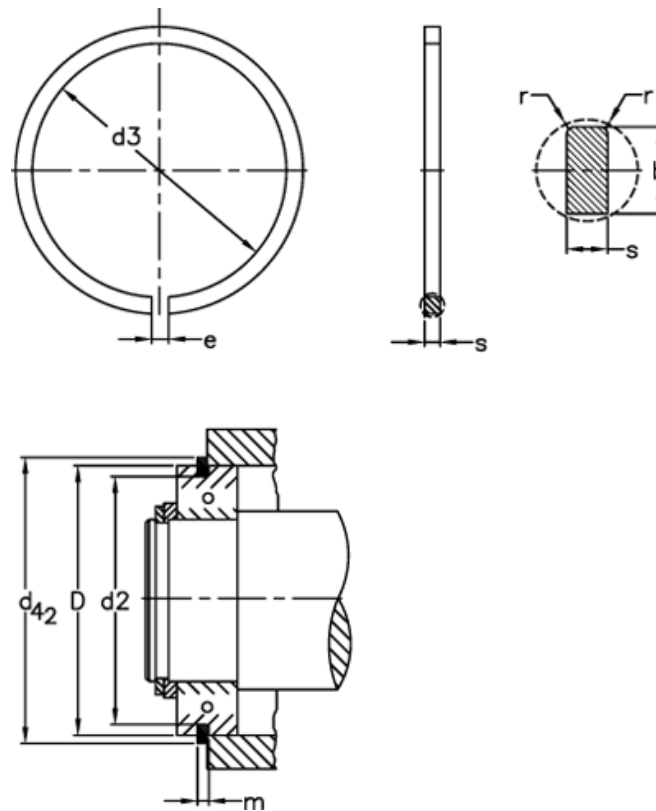

b	= 7.21	FRg kN	= 17.30	tol	= -0.15
D	= 130	FR kN	= 124.7	tol	= -0.1
d2	= 125.22	g	= 4.0	tol	= -0.50
d3	= 123.6	K kN-mm	= 269.0	tol	= 0.3
d42	= 139.7	m	= 3.10	tol	= 1.0
Description	= SP 130	n abl x 1000	= 1.0	Weight kg/1000	= 65.6
e	= 7	r min	= 0.7		
FN kN	= 166.0	s	= 2.82		